

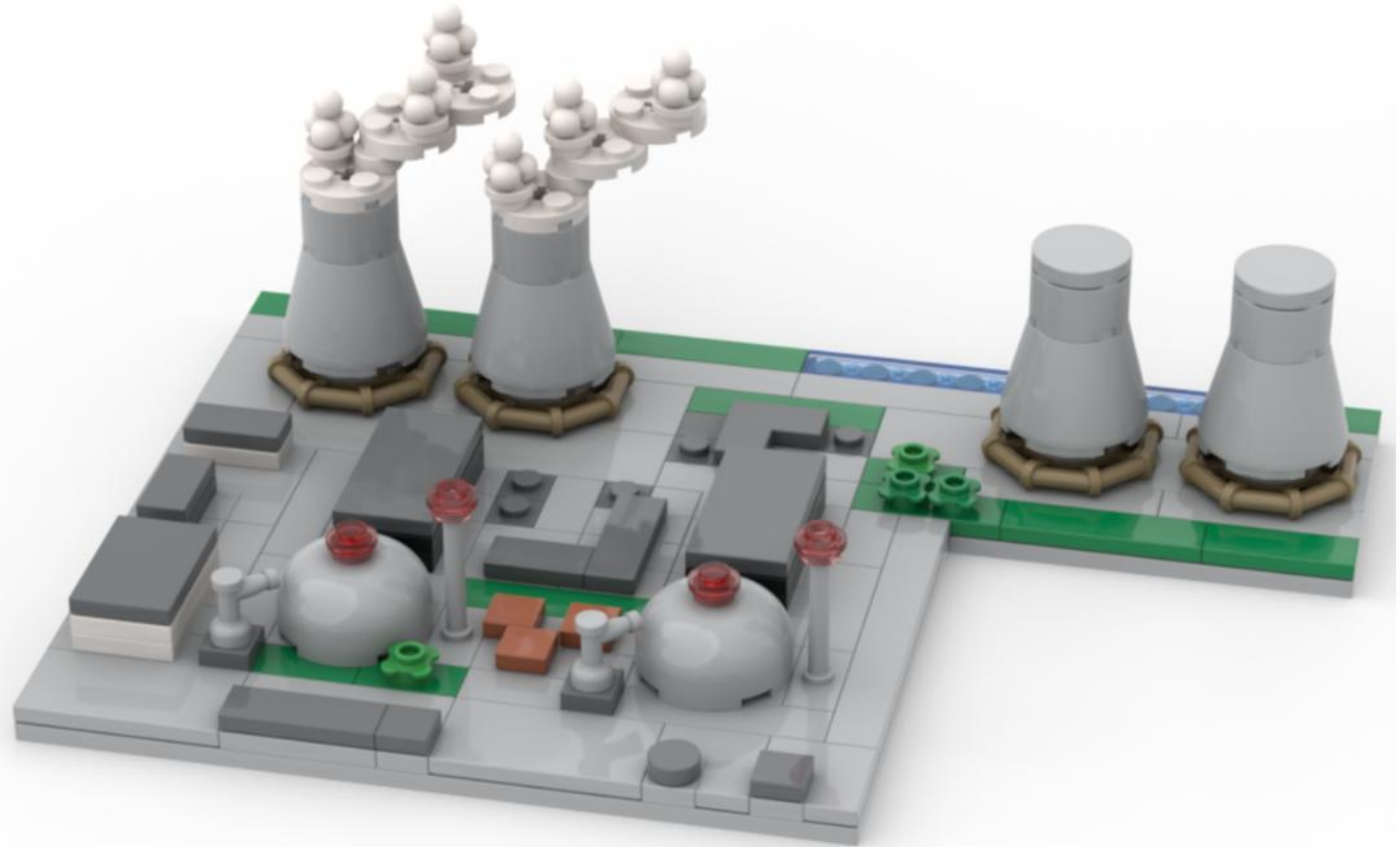

AKW

BB002
168 Teile
6+



1

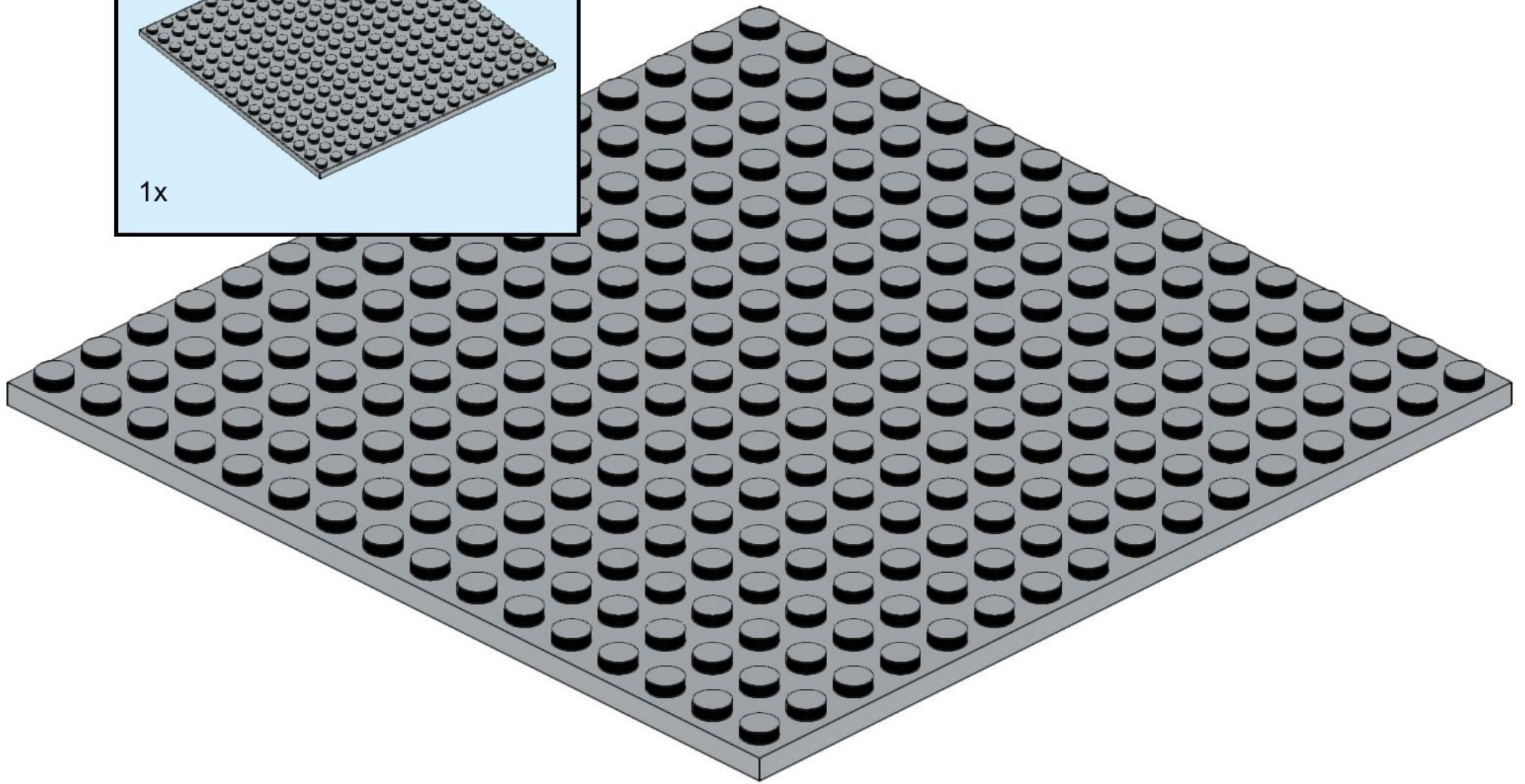
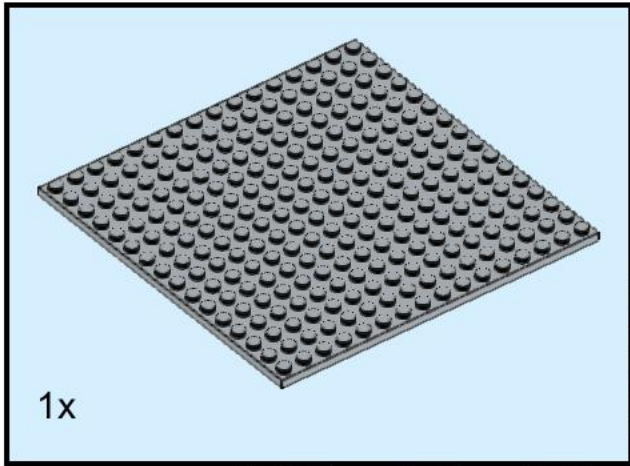

2

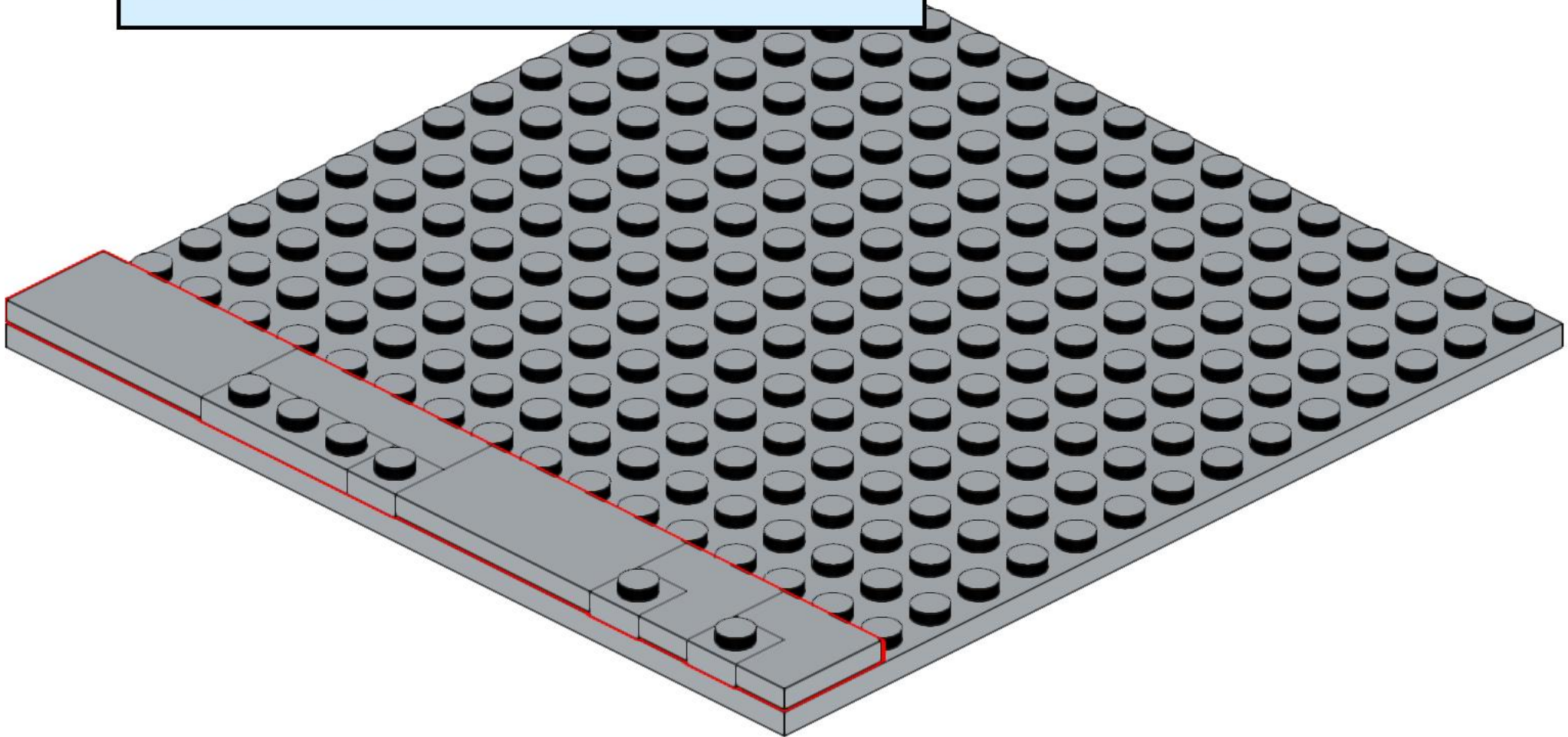
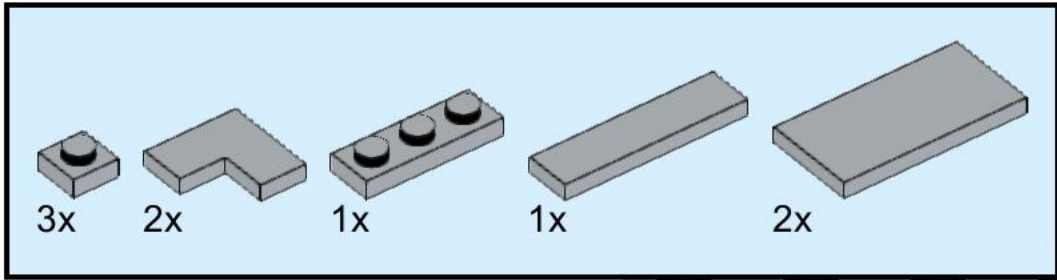

3

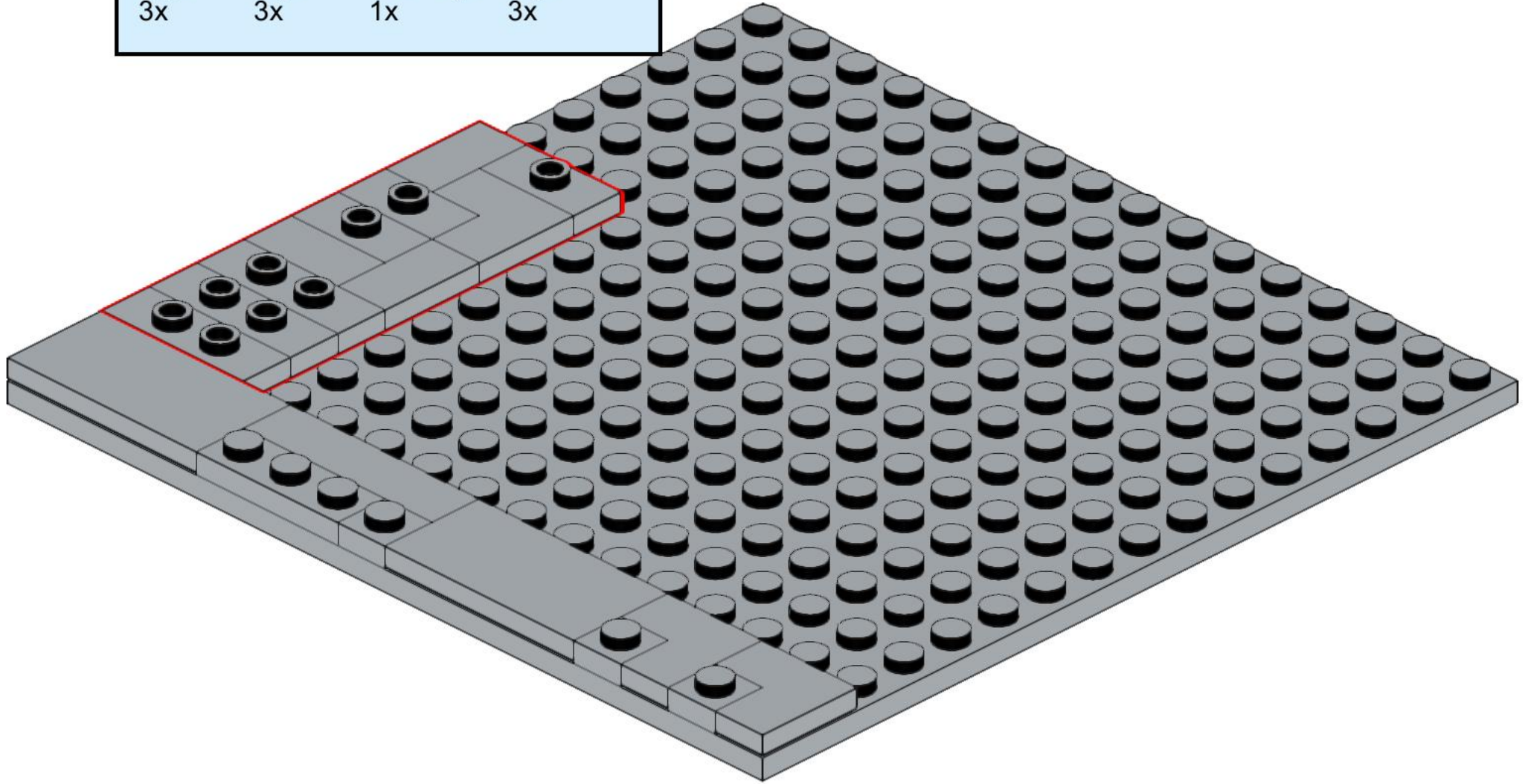
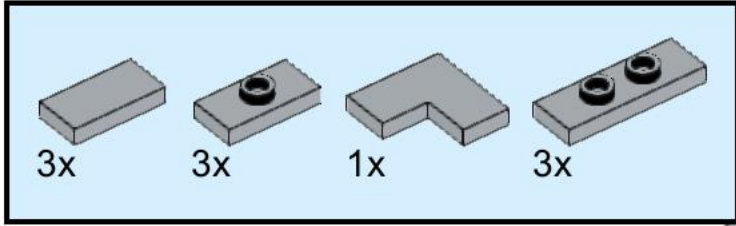

5

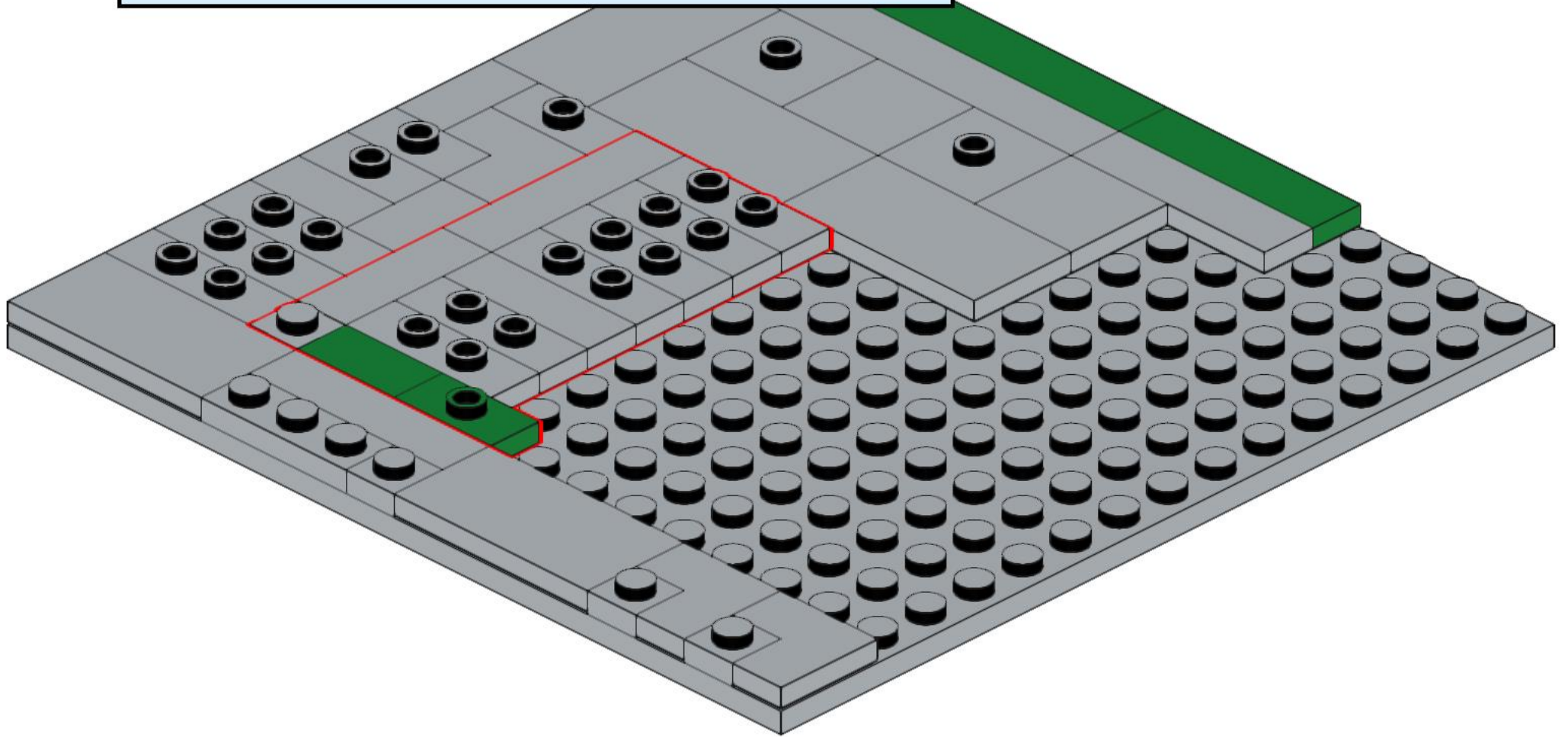
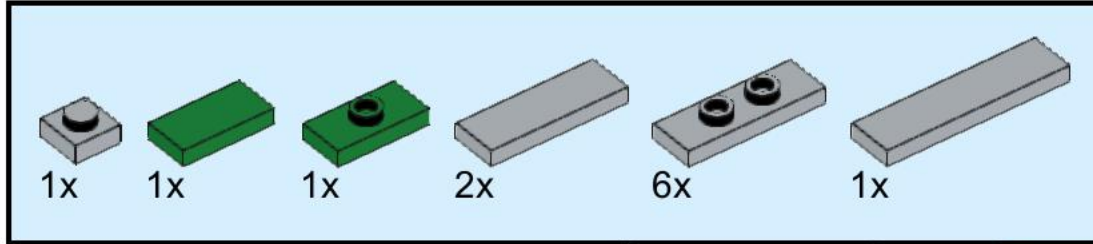

7

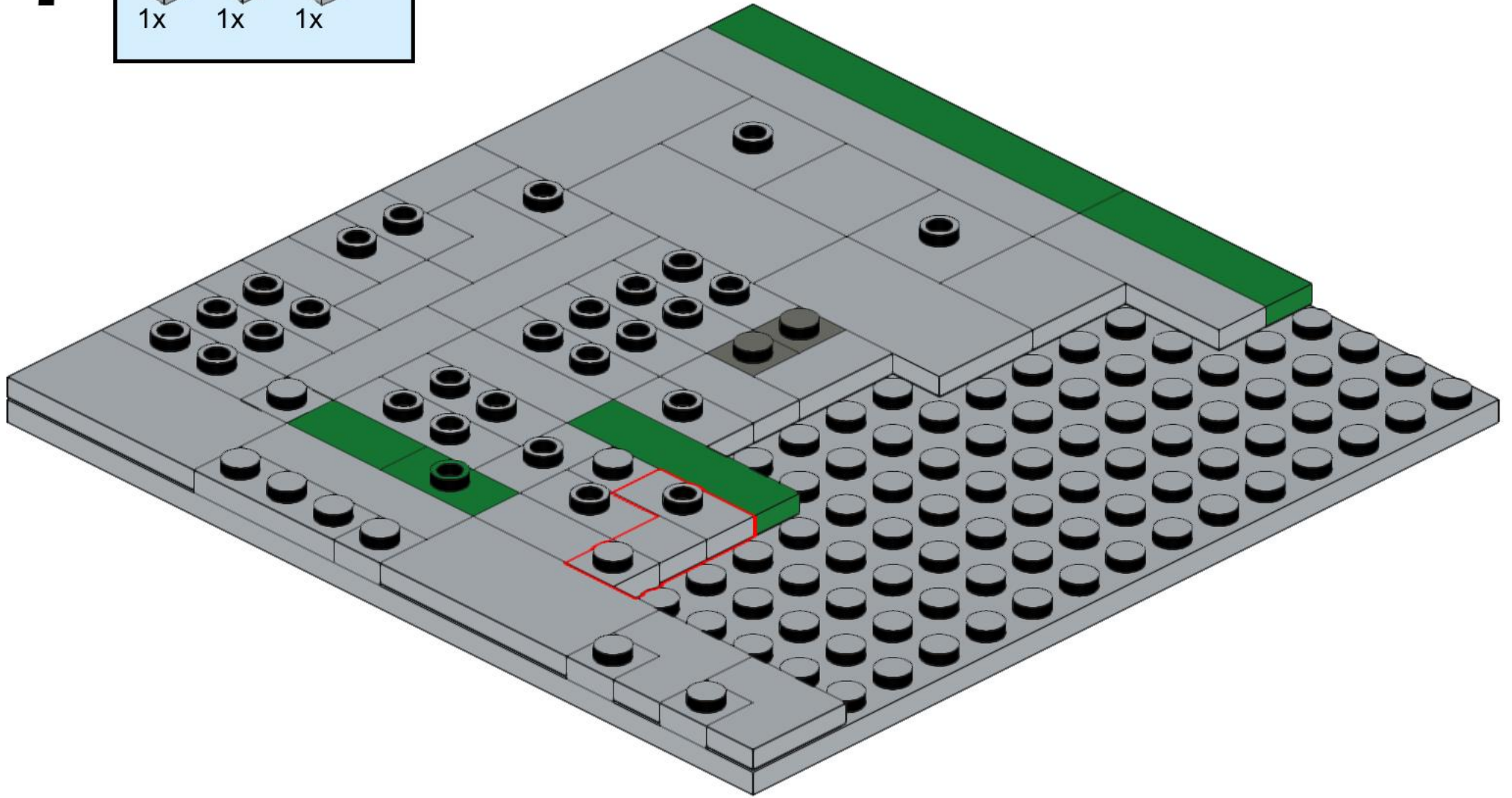
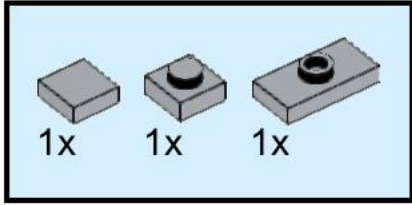

8

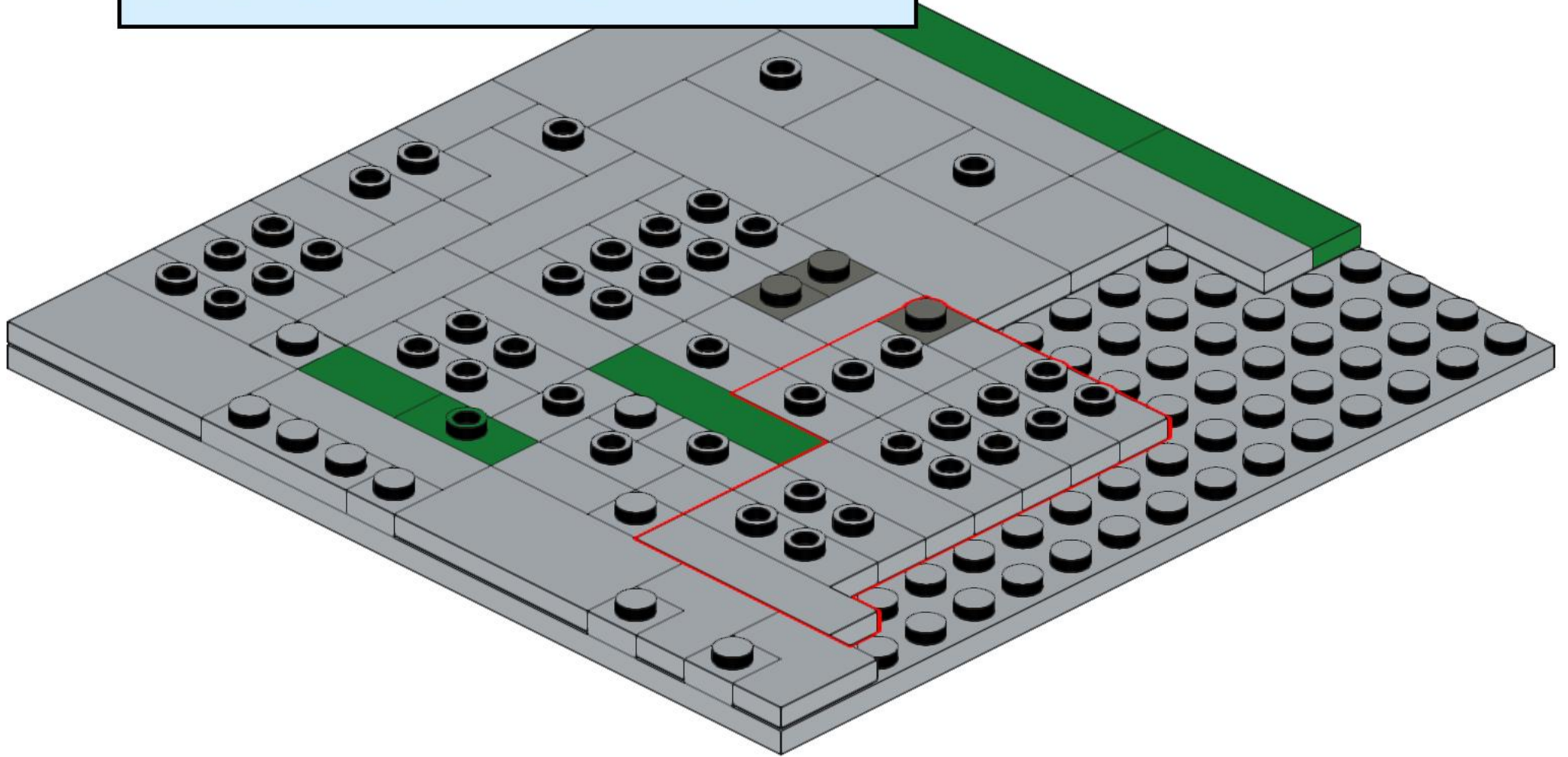
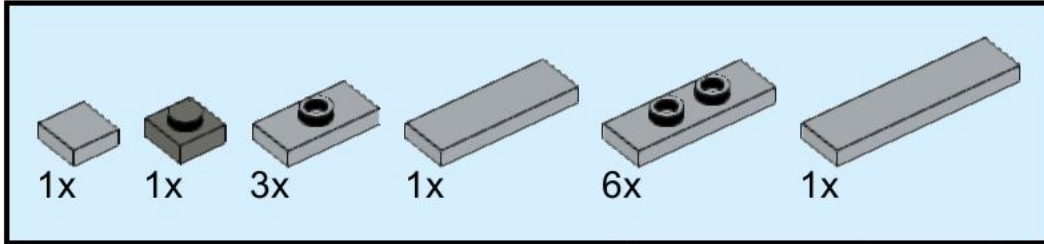

9

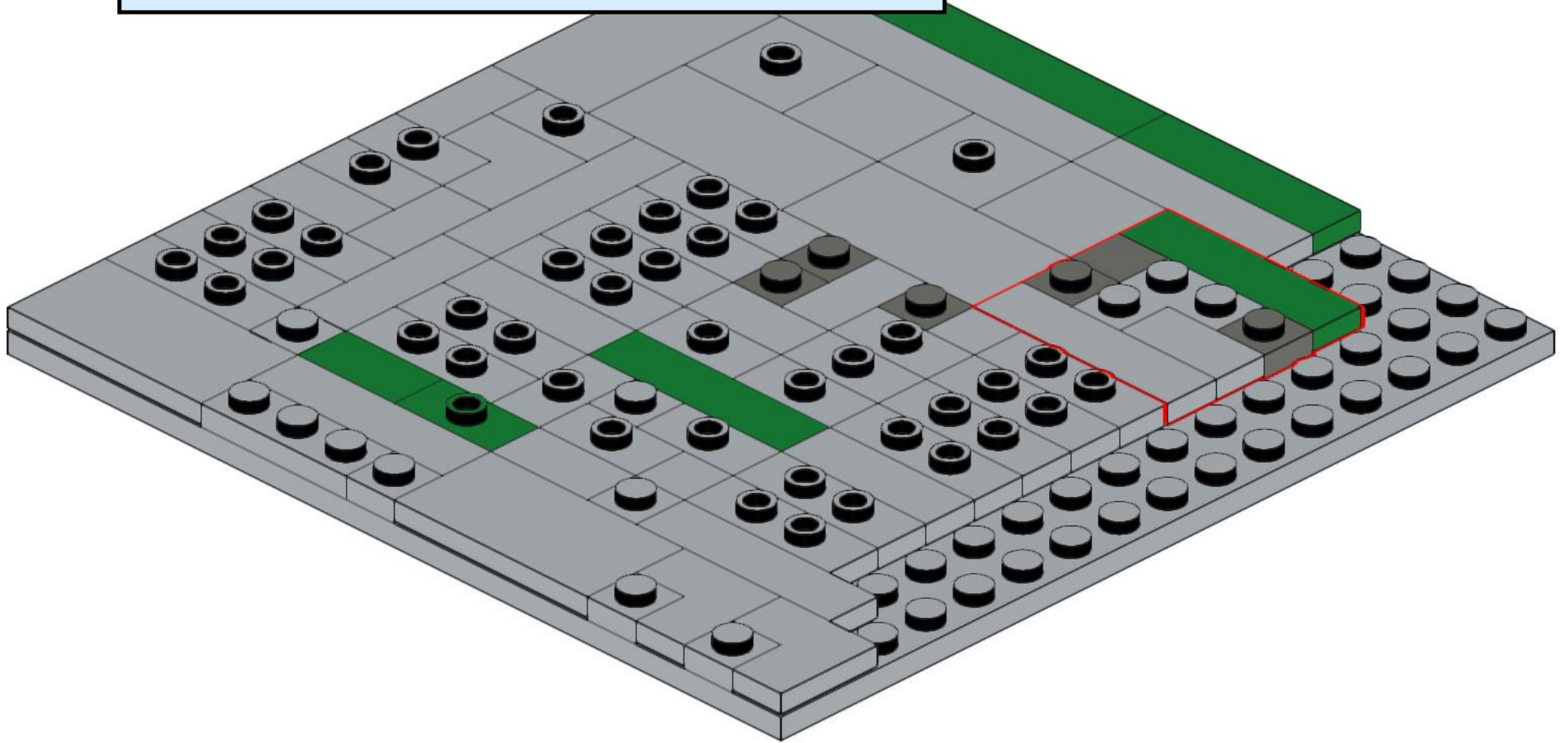
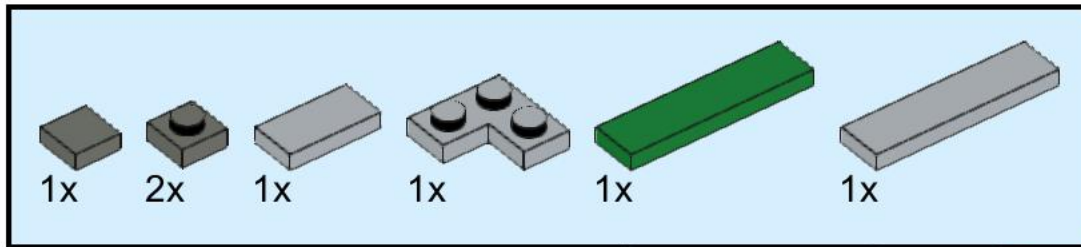

10

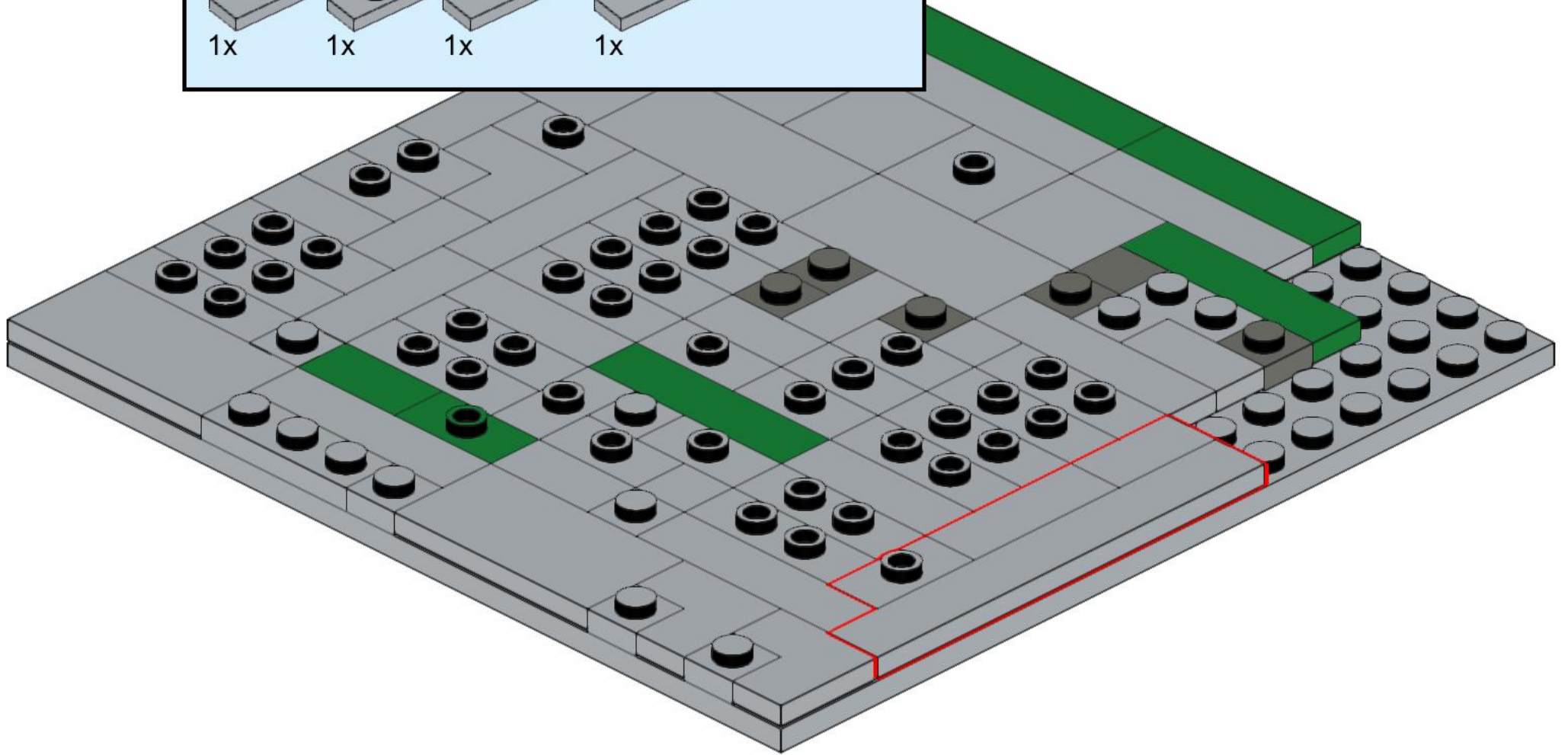
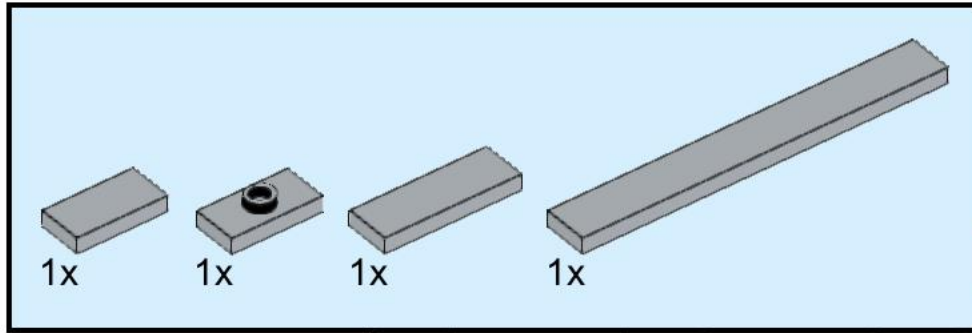

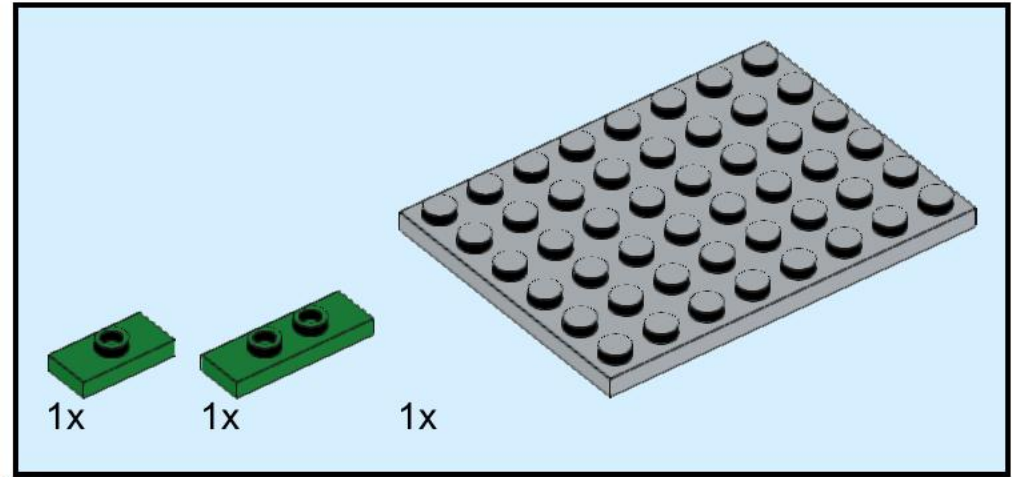
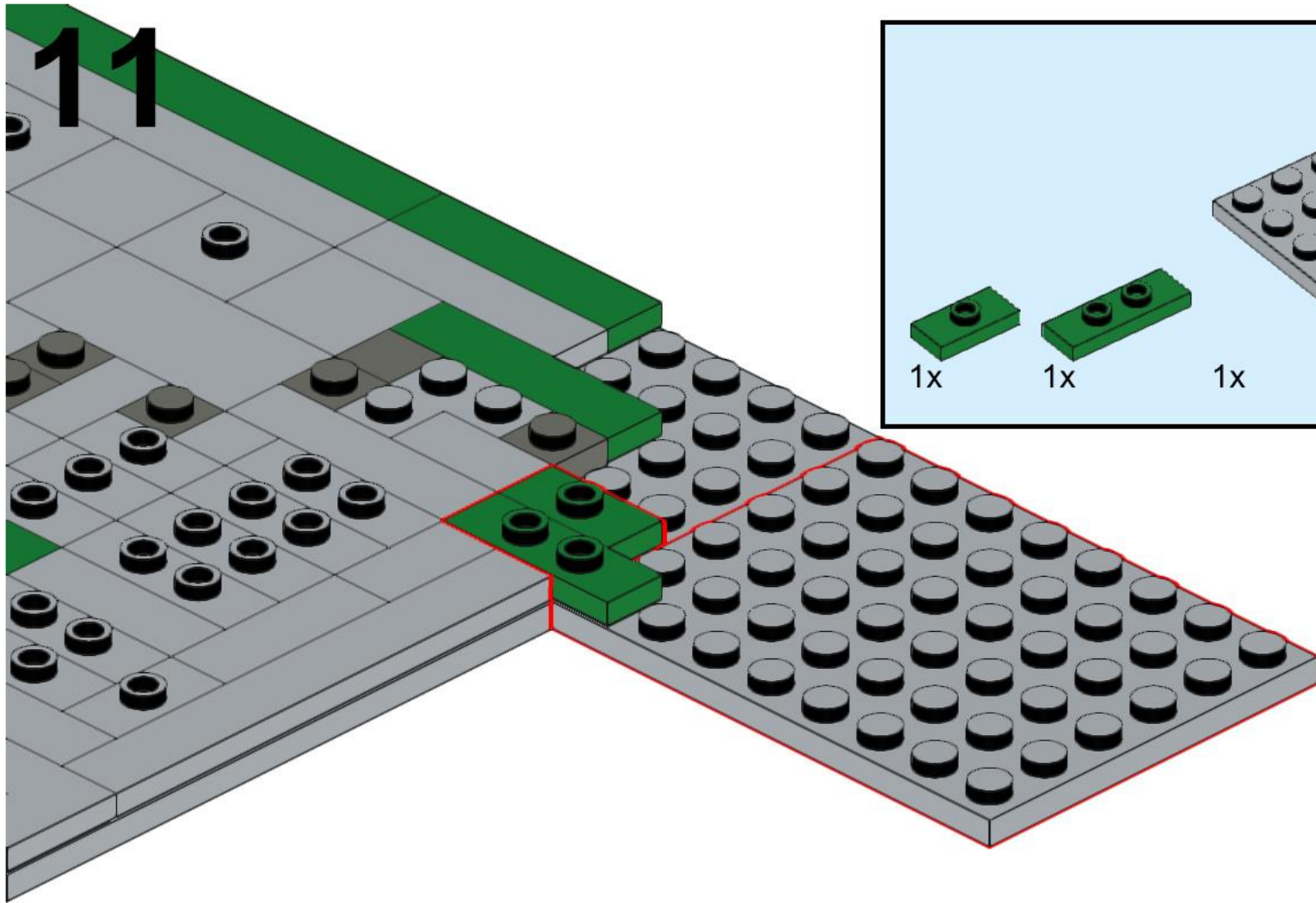

12

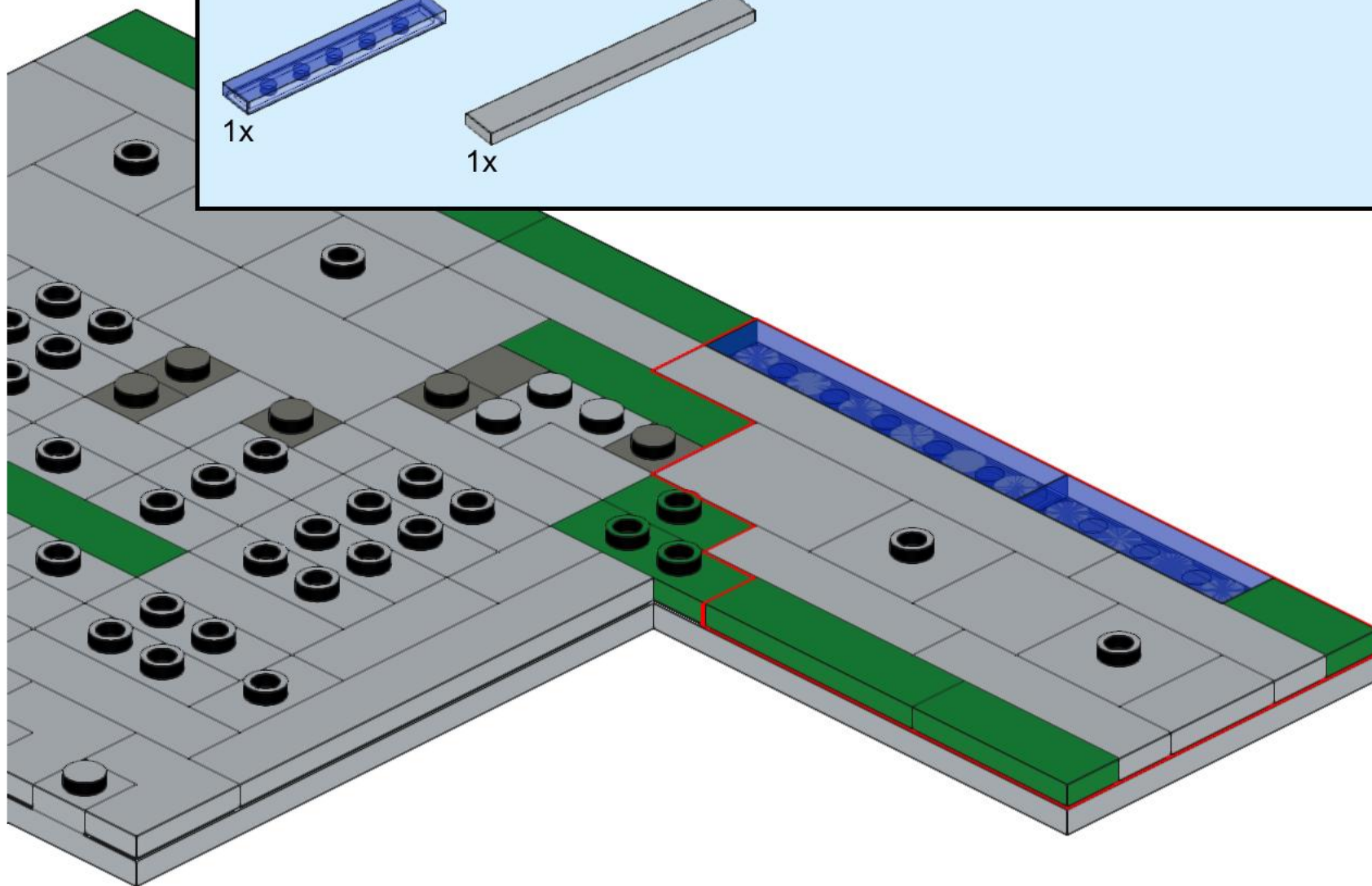
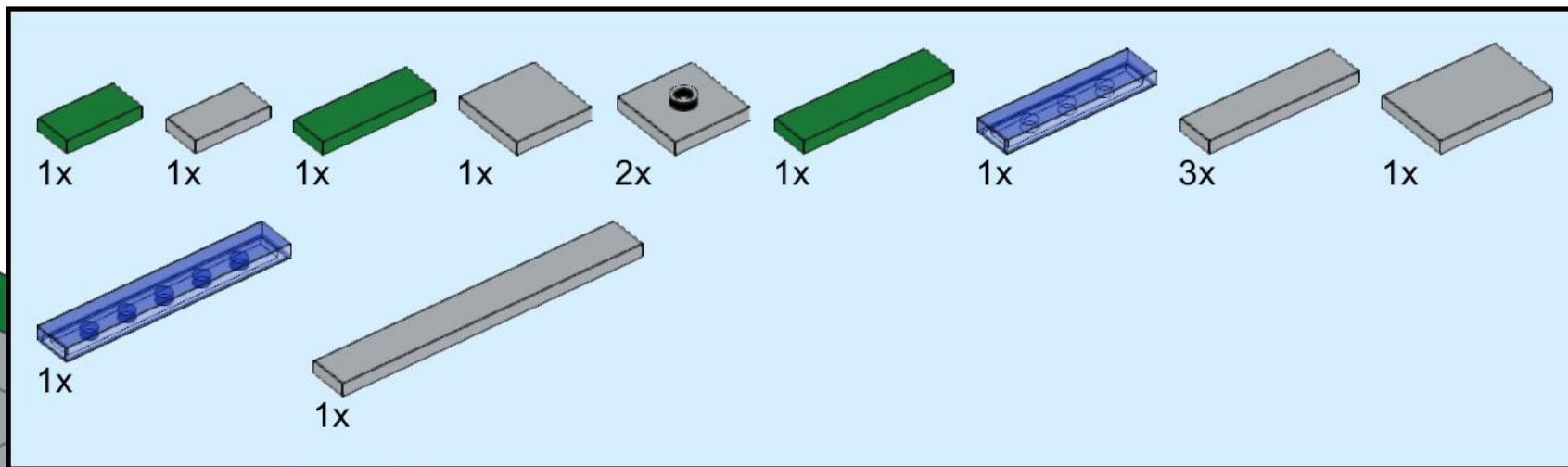

13

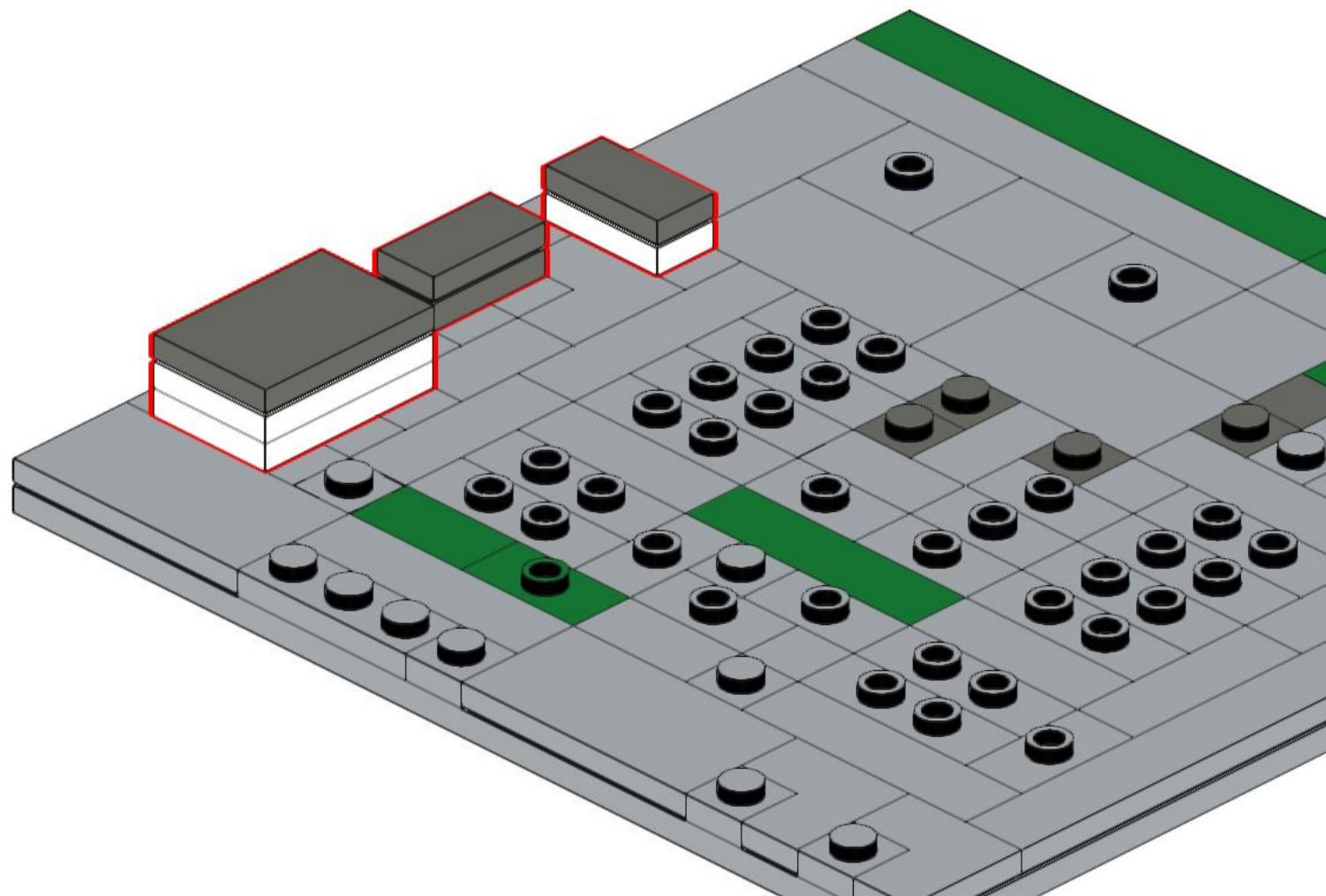
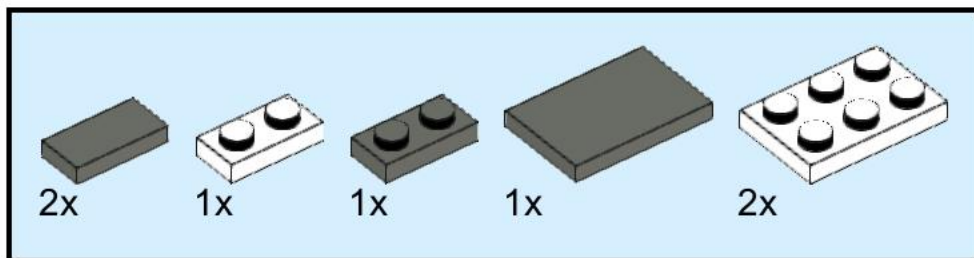

14

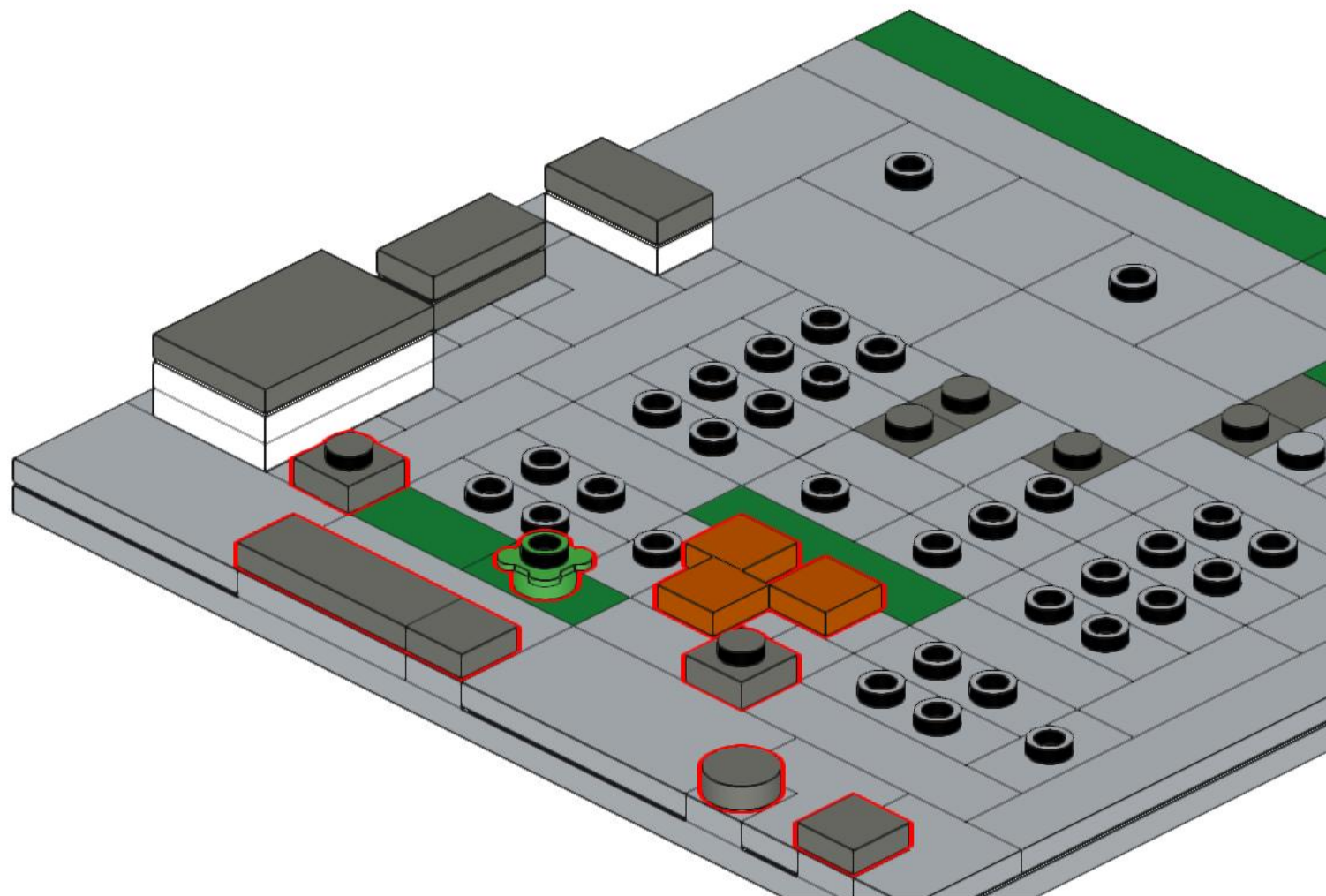
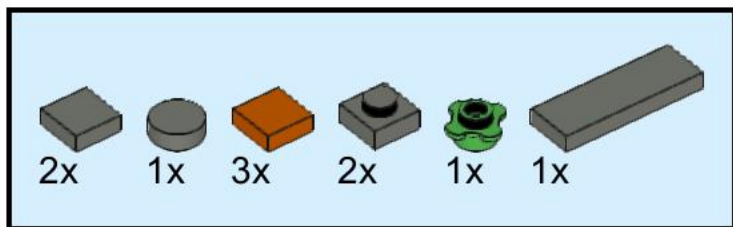

15

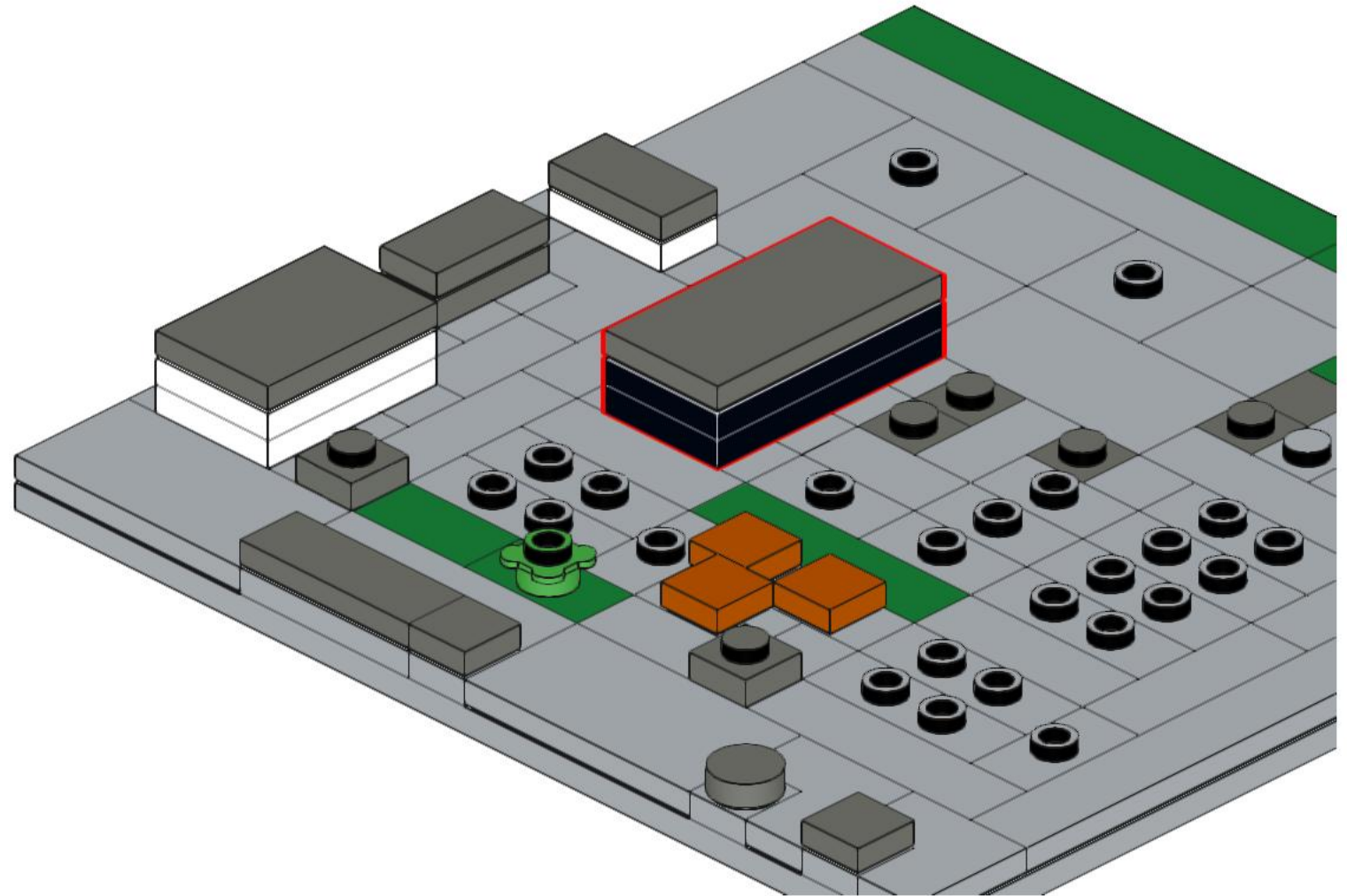
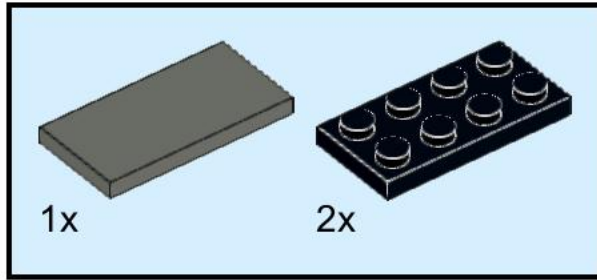

16

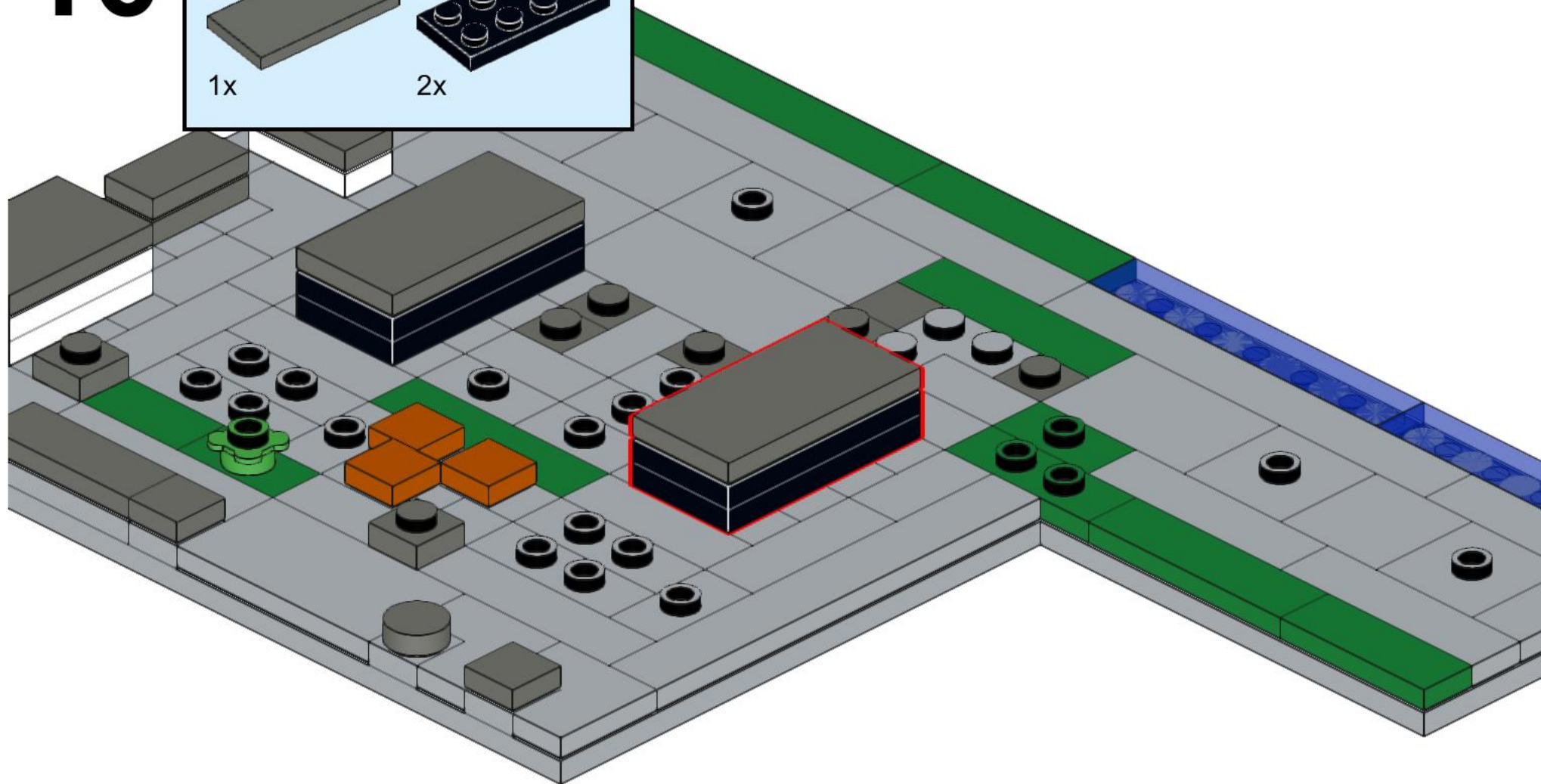
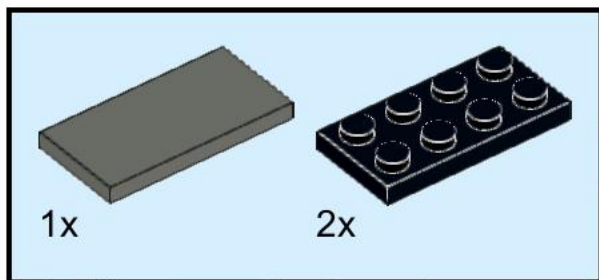

17

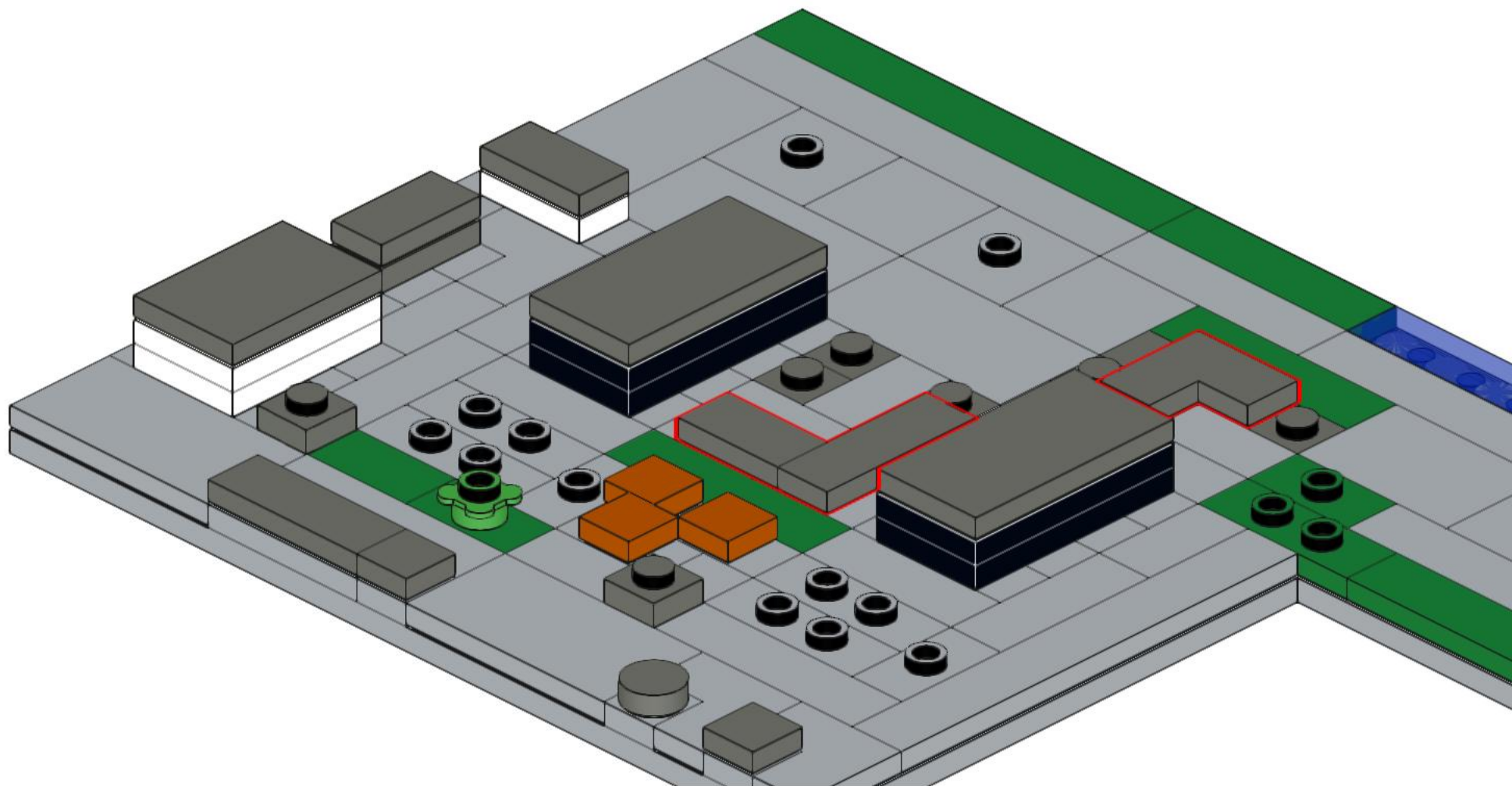
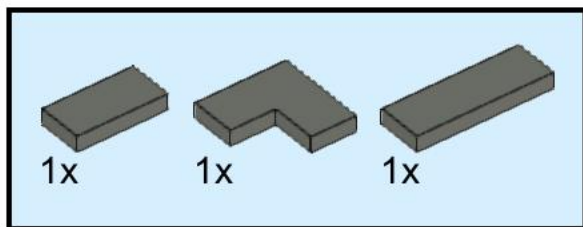

18

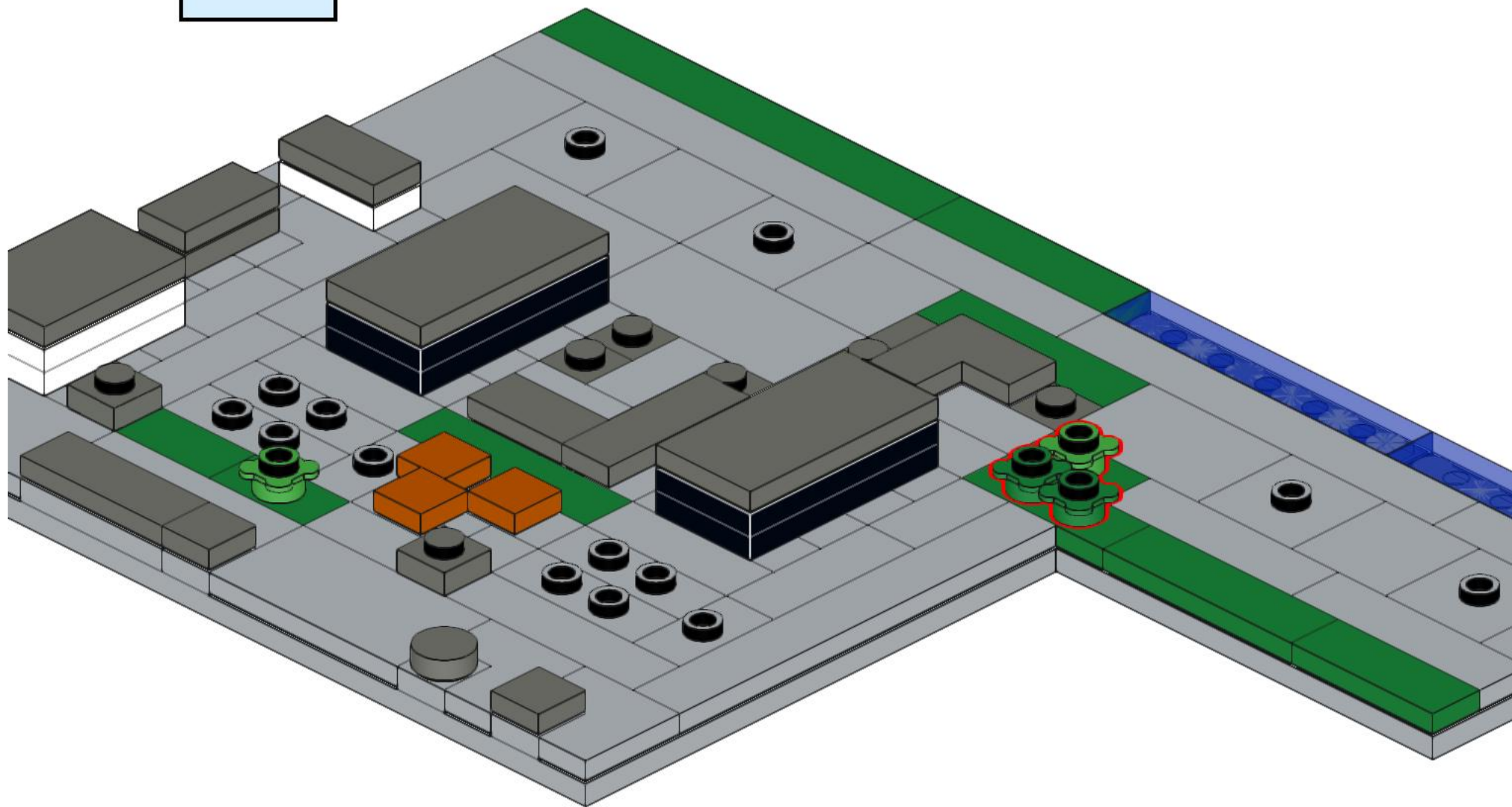
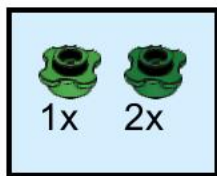

19

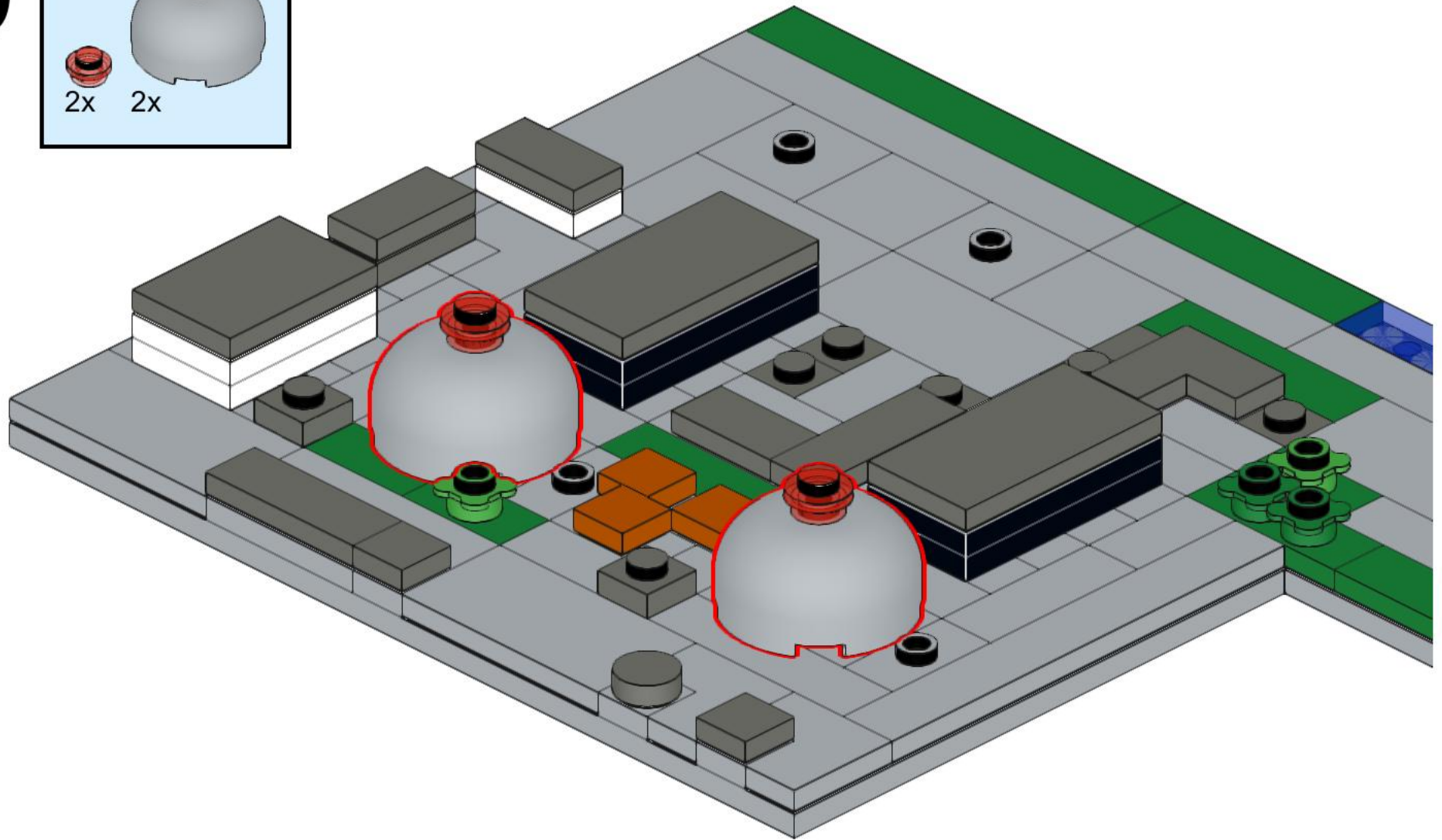
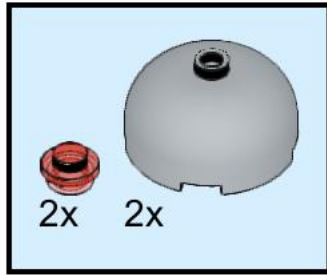

20

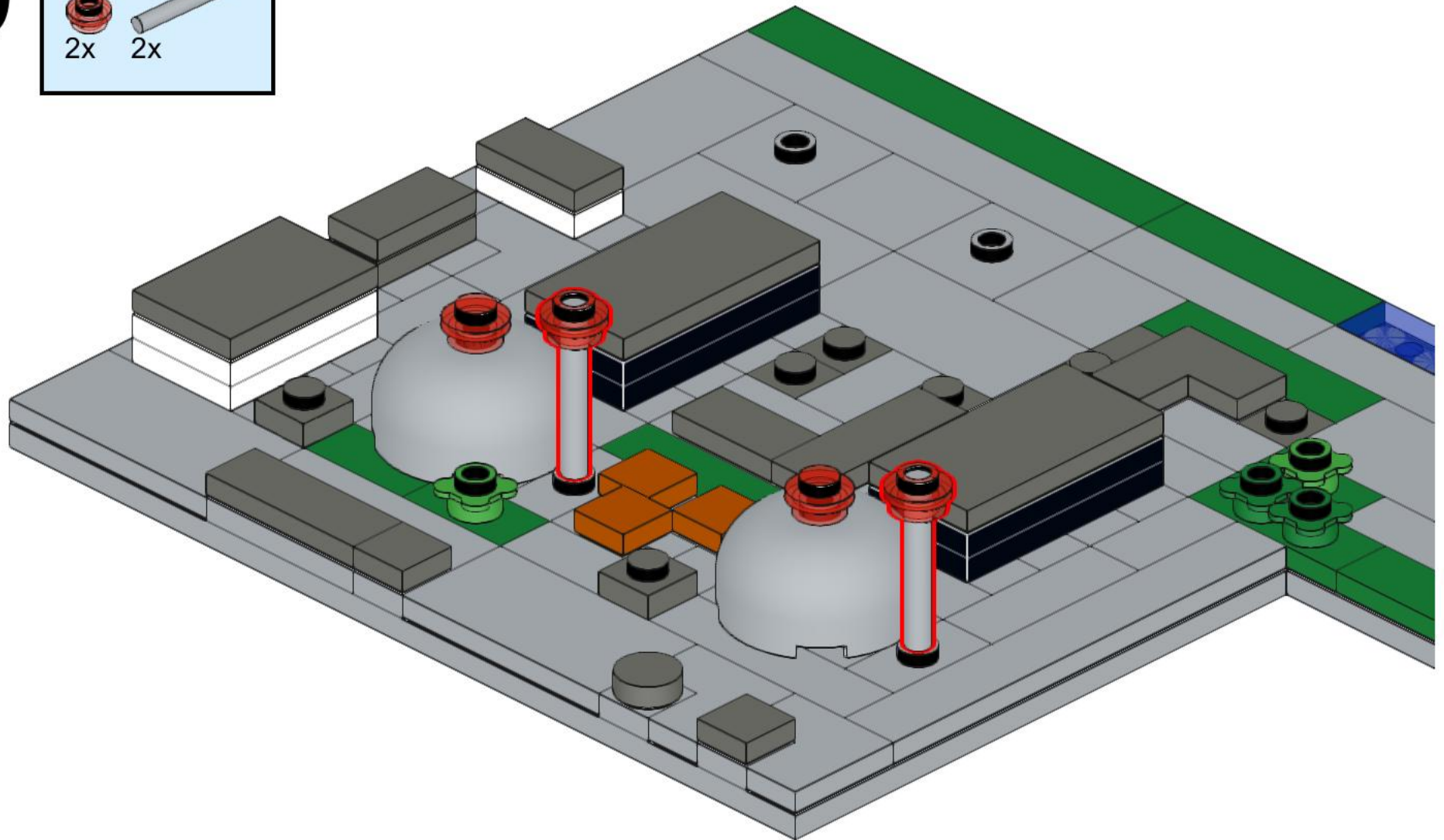
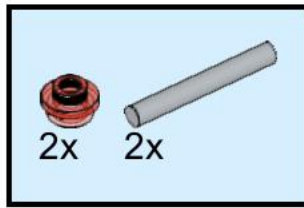

21

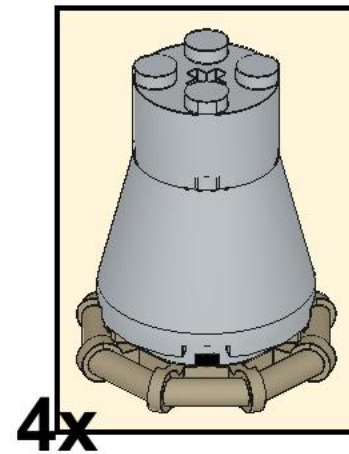
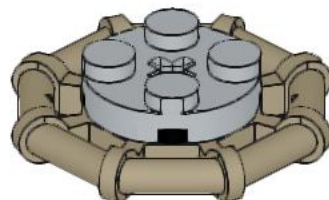
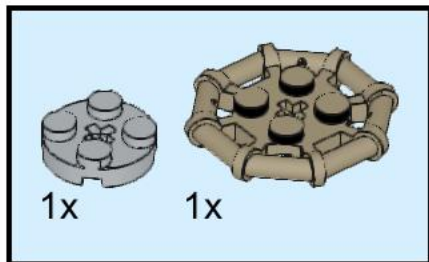

22

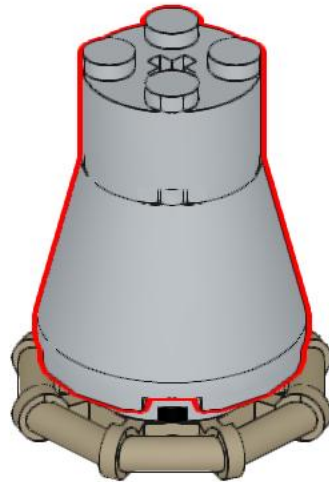
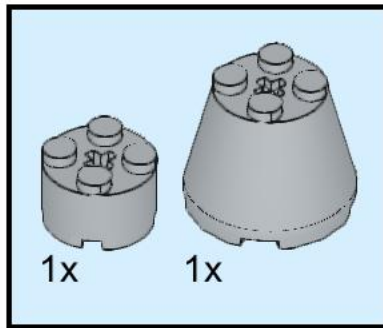

23

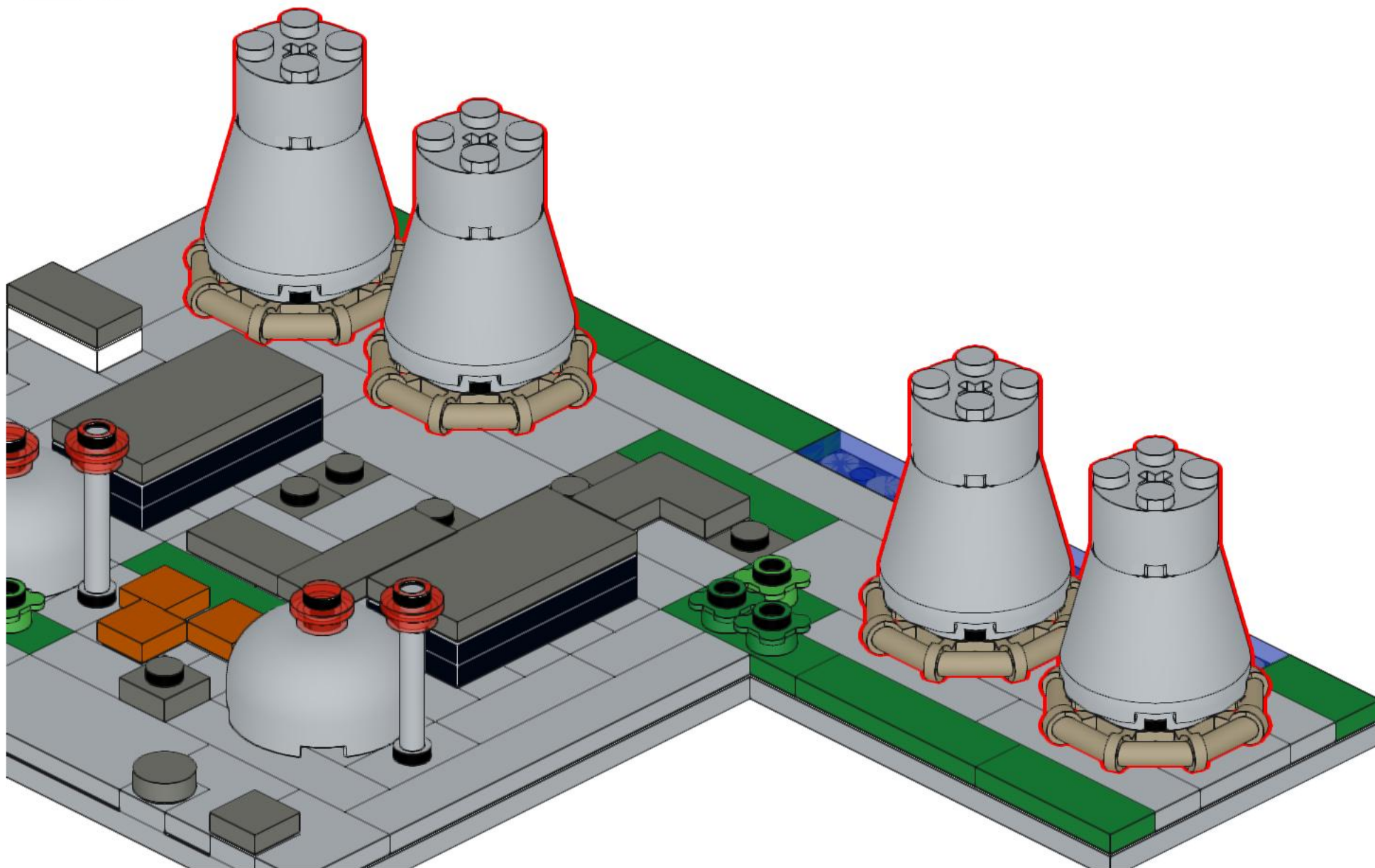

24

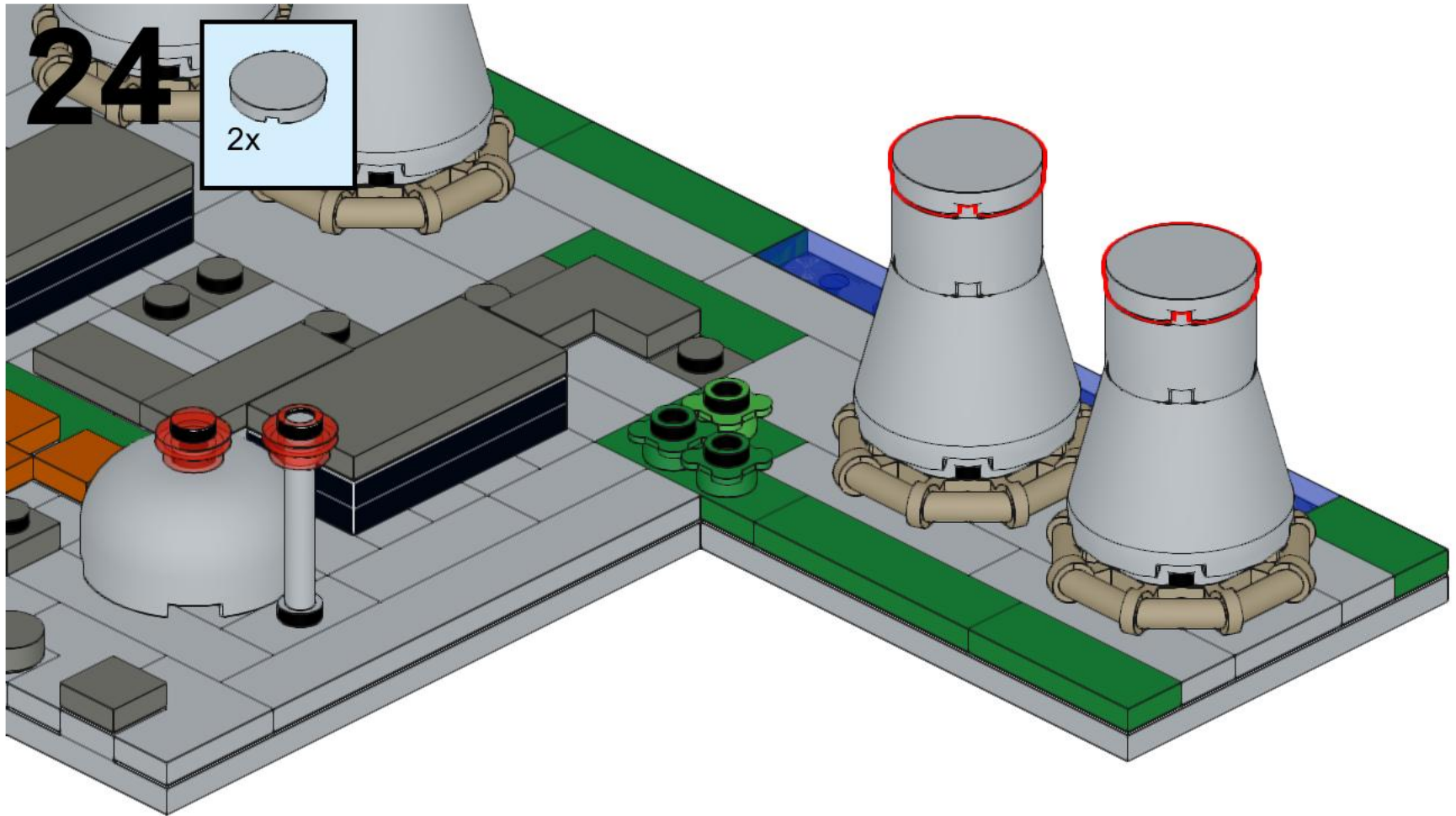

25

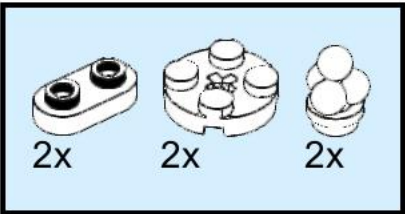
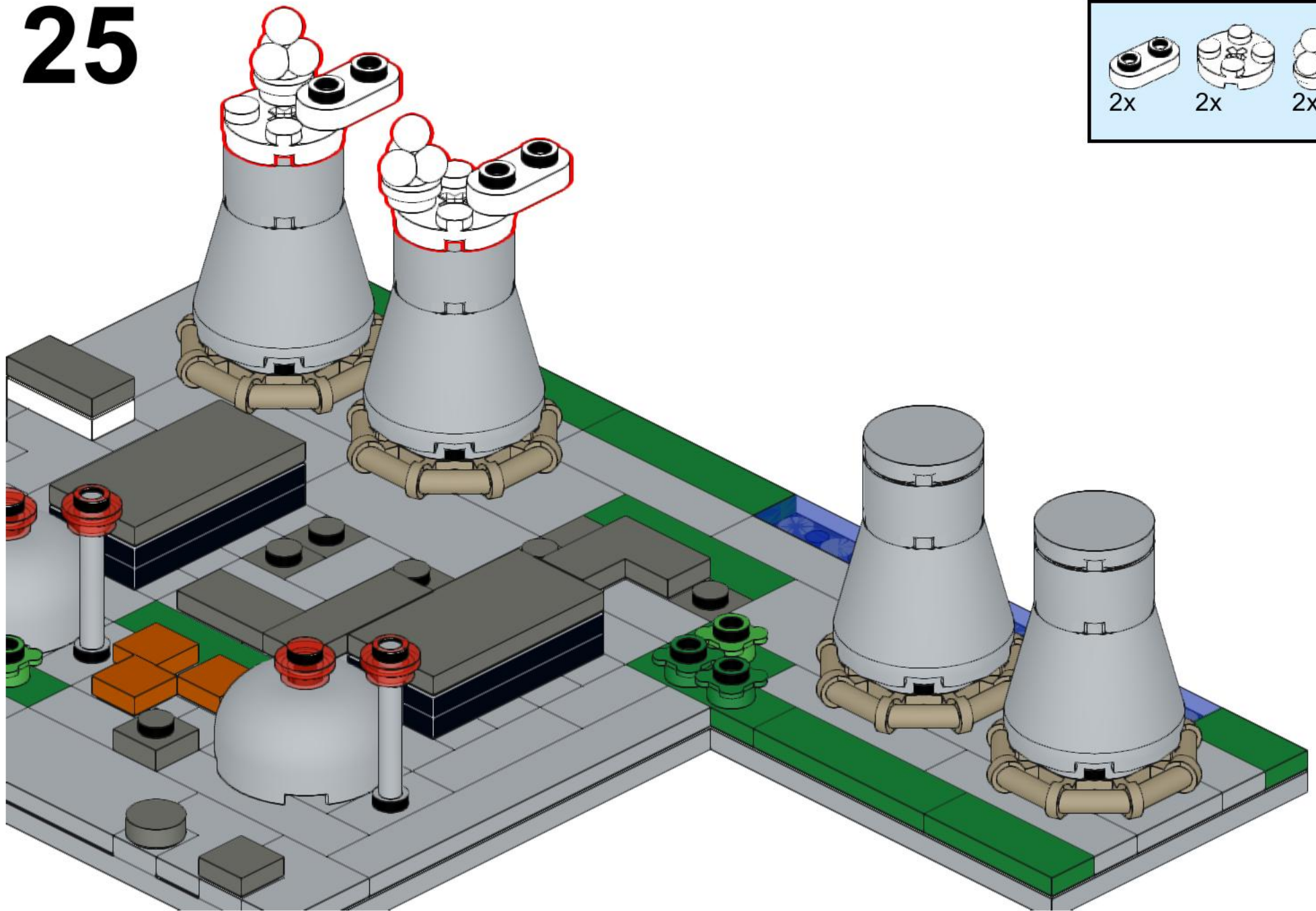

26

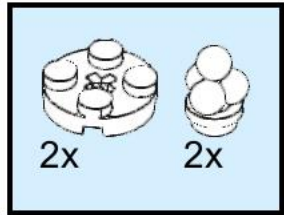
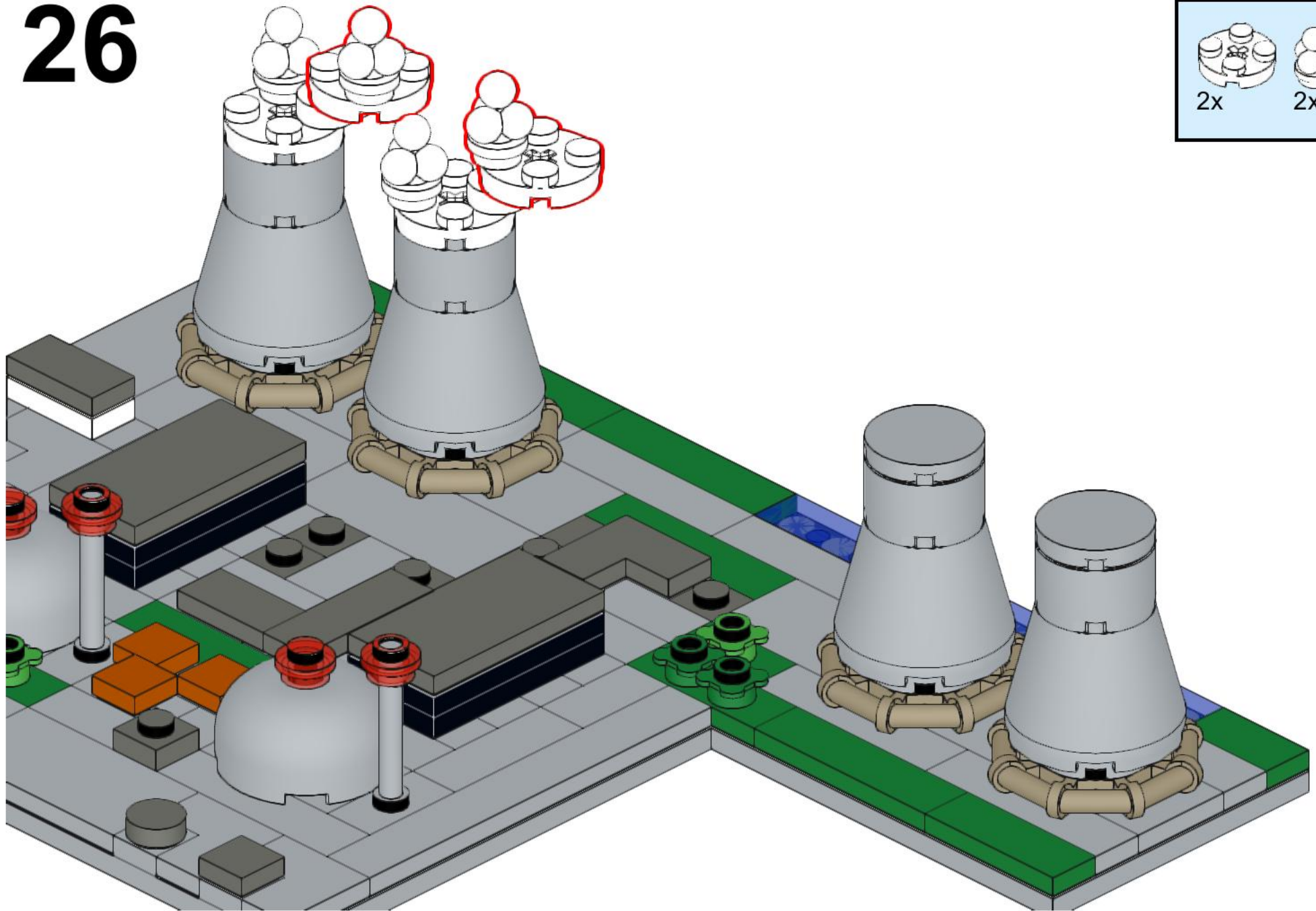

27

